

Teil 2 / Part 2			
	CEE- Gerätestecker, CEE- Kontaktarmaturen	CEE- Sockets, CEE- Terminal Boxes	Seite/Page 2.1
	CEE- Kabeldosen	CEE- Cable sockets	Seite/Page 2.2
	UFT- Gerätestecker, UFT- Kontaktarmaturen	UFT- Sockets, UFT- Terminal Boxes	Seite/Page 2.3
	GS- Kabeldosen (für UFT)	GS- Cable sockets (for UFT)	Seite/Page 2.4
	Kabelstecker (Schuko)	Cable plugs (Schuko)	Seite/Page 2.5
	Gerätestecker, Kabeldosen (HGS)	Sockets, Cable sockets (HGS)	Seite/Page 2.6
	Kabelstecker, -dose 2-polig, Typ "STA"	Cable plugs, -socket 2-pole, Type "STA"	Seite/Page 2.6
	Gerätestecker, -dosen Kabelstecker, -dosen 3-pol, 5-pol, Typ "TUC"	Plugs, Sockets Cable plugs, -sockets 3-pole, 5-pole, Type "TUC"	Seite/Page 2.7
	Mehrpolige Steckverbinder 6, 10, 16, 24 - polig	Multipole connectors 6, 10, 16, 24 - pole	Seite/Page 2.8
	Anschlußkästen	Terminal boxes	Seite/Page 2.9 - 2.10
	Aufreih-Klemmsteine	Terminal blocks	Seite/Page 2.11
	Klemmleisten	Terminal blocks	Seite/Page 2.11
	Amperemeter	Ammeter	Seite/Page 2.12
	div. Kabel, Fühlerleitungen	Cables, Wires	Seite/Page 2.13
	Isolierschläuche Rohrkabelschuhe	Glass fibre sleeving Ring terminals	Seite/Page 2.14

Gerätestecker / Sockets

Typ CEE-Norm, GE 10 CEE/1

- Eisenblech, vernickelt
- Keramik-Einsatz
- Schraubanschluß
- 3-polig
- 16A / 250V

- Steel housing
- Ceramic insert
- Screw terminals
- 3-pole socket
- 16A / 250V

max. Betriebstemperatur: 200°C
ähnlich B DIN 49 458

max. temperature: 200°C
similar to B DIN 49 458

- ... Stk./ GE 10 CEE/1



Kontaktarmatur / Terminal boxes

Typ CEE-Norm, KO 20 CEE/1

- Stahlblechgehäuse, oberflächenbehandelt
- eingebauter CEE -Gerätestecker
- 3-polig
- 16A / 250V

- Steel housing
- Inbuild CEE -plug
- 3-pole socket
- 16A / 250V

- ... Stk./ KO 20 CEE/1



L = 60 - B/W = 35 - H = 55 mm

Typ CEE-Norm, KO 30 CEE/1

- Stahlblechgehäuse, oberflächenbehandelt
- eingebauter CEE -Gerätestecker
- 3-polig
- 16A / 250V

- Steel housing
- Inbuild CEE -plug
- 3-pole socket
- 16A / 250V

- ... Stk./ KO 30 CEE/1



L = 65 - B/W = 55 - H = 50 mm

Kabeldosen, Kunststoff-Gehäuse / Cable Sockets, Plastic housing

Typ CEE 25

- Gehäuse: Kunststoff
- Einsatz: Keramik
- Ausführung: gerade
- 2-polig mit Schutzkontakt
- 16 A / 250 V

- Housing: Plastic
- Insert: Ceramic
- Construction: straight
- 2-pole with earth contact
- 16 A / 250 V

max. Betriebstemperatur: 200°C
ähnlich B DIN 49 458

max. temperature: 200°C
similar to B DIN 49 458

- ... Stk./ CEE 25



Typ CEE 20

- Gehäuse: Kunststoff
- Einsatz: Keramik
- Ausführung: abgewinkelt, 90°
- 2-polig mit Schutzkontakt
- 16 A / 250 V

- Housing: Plastic
- Insert: Ceramic
- Construction: angled, 90°
- 2-pole with earth contact
- 16 A / 250 V

max. Betriebstemperatur: 200°C
ähnlich B DIN 49 458

max. temperature: 200°C
similar to B DIN 49 458

- ... Stk./ CEE 20



Kabeldosen, Vollgummi / Cable Sockets, Solid-rubber housing

Typ CEE 25 VG

- Gehäuse: Vollgummi
- Ausführung: gerade
- 2-polig mit Schutzkontakt
- 10/16 A / 250 V

- Housing: solid-rubber
- Construction: straight
- 2-pole socket with earth contact
- 10/16 A / 250 V

max. Betriebstemp.: 200°C,
kurzfristig 300°C

max. temperature: 200°C,
short-term 300°C

- ... Stk./ CEE 25 VG



Typ CEE 20 VG

- Gehäuse: Vollgummi
- Ausführung: abgewinkelt, 90°
- 2-polig mit Schutzkontakt
- 10/16 A / 250 V

- Housing: solid-rubber
- Construction: angled, 90°
- 2-pole socket with earth contact
- 10/16 A / 250 V

max. Betriebstemp.: 200°C,
kurzfristig 300°C

max. temperature: 200°C,
short-term 300°C

- ... Stk./ CEE 20 VG



Gerätestecker / Sockets

Typ UFT

- | | |
|--|--|
| <ul style="list-style-type: none"> • Eisenblech, vernickelt • bewegliche Messing-Kontaktstifte und Keramik-Isolatoren • Schraubanschluß • 2-polig, UFT • 10 A / 250 V | <ul style="list-style-type: none"> • Nickel-plated steel • self-aligning brass pins and ceramic insulation • Screw terminals • 2-pole socket UFT • 10 A / 250 V |
|--|--|



- ... Stk./ UFT

Kontaktarmaturen / Terminal boxes

Typ KO 20 ST

- | | |
|---|--|
| <ul style="list-style-type: none"> • Stahlblechgehäuse, oberflächenbehandelt • eingebauter Gerätestecker, bewegliche Steckerstifte • 2-polig • 10 A / 250 V | <ul style="list-style-type: none"> • metal-housing • inbuild 2-pole socket UFT • 10 A / 250 V |
|---|--|



L = 50 - B/W = 30 - H = 55 mm

- ... Stk./ KO 20 ST

Typ KO 22 ST

- | | |
|---|--|
| <ul style="list-style-type: none"> • Stahlblechgehäuse, oberflächenbehandelt • aufgebauter Gerätestecker, bewegliche Steckerstifte • 2-polig • 10 A / 250 V | <ul style="list-style-type: none"> • metal-housing • inbuild 2-pole socket UFT • 10 A / 250 V |
|---|--|



L = 70 - B/W = 45 - H = 40 mm

- ... Stk./ KO 22 ST

Typ KO 30 ST

- | | |
|---|--|
| <ul style="list-style-type: none"> • Stahlblechgehäuse, oberflächenbehandelt • eingebauter Gerätestecker, bewegliche Steckerstifte • 2-polig • 10 A / 250 V | <ul style="list-style-type: none"> • metal-housing • inbuild 2-pole socket UFT • 10 A / 250 V |
|---|--|



L = 65 - B/W = 50 - H = 35 mm

- ... Stk./ KO 30 ST

Kabeldosen, Alu--Gehäuse / Cable Sockets, Aluminium housing

Typ GS 25

- Gehäuse: Alu-Druckguß
- Einsatz: Keramik
- Ausführung: gerade
- 2-polig mit Schutzkontakt
- 25 A / 400 V

- Housing: Die-cast aluminium
- Insert: Ceramic
- Construction: straight
- 2-pole with earth contact
- 25 A / 400 V



- ... Stk./ GS 25

Typ GS 20

- Gehäuse: Alu-Druckguß
- Einsatz: Keramik
- Ausführung: abgewinkelt, 90°
- 2-polig mit Schutzkontakt
- 25 A / 400 V

- Housing: Die-cast aluminium
- Insert: Ceramic
- Construction: angled, 90°
- 2-pole with earth contact
- 25 A / 400 V



- ... Stk./ GS 20

Kabeldosen, Vollgummi / Cable Sockets, Solid-rubber housing

Typ GS 25 VG

- Gehäuse: Vollgummi
- Ausführung: gerade
- 2-polig mit Schutzkontakt
- 10/16 A / 250 V (25A auf Anfrage)

- Housing: solid-rubber plug
- Construction: straight
- 2-pole socket with earth contact
- 10/16 A / 250 V (25 A on request)

max. Betriebstemp.: 200°C,
kurzfristig 300°C

max. temperature: 200°C,
short-term 300°C



- ... Stk./ GS 25 VG

Typ GS 20 VG

- Gehäuse: Vollgummi
- Ausführung: abgewinkelt, 90°
- 2-polig mit Schutzkontakt
- 10/16 A / 250 V (25A auf Anfrage)

- Housing: solid-rubber plug
- Construction: angled, 90°
- 2-pole socket with earth contact
- 10/16 A / 250 V (25 A on request)

Betriebstemperatur: 200°C,
kurzfristig 300°C

max. temperature: 200°C,
short-term 300°C



- ... Stk./ GS 20 VG

Kabelstecker
Cable plugs

Kabelstecker / Cable plugs

Typ Schuko SST 10

- Kunststoffgehäuse,
 - 2-polig mit Schutzkontakt
 - 10A / 250V
- Plastic housing
 - 2-pole with earth contact
 - 10A / 250V



- ... Stk./ SST 10

Typ Schuko 90° SSF 20

- Kunststoffgehäuse,
 - seitliche Kabeleinführung
 - 2-polig mit Schutzkontakt
 - 10A / 250V
- Plastic housing
 - Construction: side entry cable, 90°
 - 2-pole with earth contact
 - 10A / 250V



- ... Stk./ SSF 20

Typ Schuko SVG 30

- Vollgummigehäuse,
 - zentrale Kabeleinführung
 - 2-polig mit Schutzkontakt
 - 10A / 250V
- Solid rubber-housing
 - 2-pole with earth contact
 - 10A / 250V



- ... Stk./ SVG 30

Gerätestecker, Kabel Dosen / Sockets, Cable sockets

Typ HGS 25

- nach VDE 035
- Steckanschluß 4,8
- Aufbaumontage
- 3-polig
- 10 A / 250 V

- corresponding to VDE 035
- Plug connection 4,8
- Surface mounting
- 3-pole socket
- 10 A / 250 V

max. Betriebstemperatur: 200°C

max. temperature: 200°C

- ... Stk./ HGS-25



Typ HGK 25

- nach VDE 035
- für Steckanschluß 4,8
- Gehäuse und Kontaktträger: Kunststoff
- 3-polig
- 10 A / 250 V

- corresponding to VDE 035
- for plug connection 4,8
- Housing and terminal block: Plastic
- 3-pole socket
- 10 A / 250 V

max. Betriebstemperatur: 200°C

max. temperature: 200°C

- ... Stk./ HGK-25



Kabelstecker, -dose / Cable plugs, -socket

Typ STA/K

- Gehäuse: Kunststoff, bruchsicher, schlagfest
- Zugentlastung PG 7
- Sicherungsbügel
- 2-polig mit Schutzkontakt
- 12 A / 250 V

- Housing: Plastic
- PG 7 Cable clamp
- with securing-clip fixation
- 2-pole and earth contact
- 12 A / 250 V

max. Betriebstemperatur: 90°C

max. temperature: 90°C

- ... Stk./ STA/K



Typ STA/S

- Gehäuse: Kunststoff, bruchsicher, schlagfest
- Zugentlastung PG 7
- 2-polig mit Schutzkontakt
- 12 A / 250 V

- Solid plastic housing
- PG 7 Cable clamp
- 2-pole and earth contact
- 12 A / 250 V

max. Betriebstemperatur: 90°C

max. temperature: 90°C

- ... Stk./ STA/S



Rundsteckverbinder
Circular plugs

Gerätestecker, -dose / Plugs, sockets

Typ GS-TUC

- Gehäuse: PETP gv.
- Bajonettverriegelung
- Lötanschlüsse
- 3 oder 5-polig
- 10 A / 250 V

- Housing: PETP gv.
- Bayonet-locking
- Solder terminals
- 3 or 5-pole
- 10 A / 250 V

max. Betriebstemperatur: 85°C

max. temperature: 85°C

- 3-POL: ... Stk./ GS-TUC / 3
- 5-POL: ... Stk./ GS-TUC / 5



Typ GD-TUC

- Gehäuse: PETP gv.
- Bajonettverriegelung
- Lötanschlüsse
- 3 oder 5-polig
- 10 A / 250 V

- Housing: PETP gv.
- Bayonet-locking
- Solder terminals
- 3 or 5-pole
- 10 A / 250 V

max. Betriebstemperatur: 85°C

max. temperature: 85°C

- 3-POL: ... Stk./ GD-TUC / 3
- 5-POL: ... Stk./ GD-TUC / 5



Kabelstecker / Cable plug

Typ KS-TUC

- Gehäuse und Kontaktträger: PETP gv.
- Bajonettverriegelung
- Lötanschlüsse
- 3 oder 5-polig
- 10 A / 250 V

- Housing and terminal block: PETP gv.
- Bayonet-locking
- Solder terminals
- 3 or 5-pole
- 10 A / 250 V

max. Betriebstemperatur: 85°C

max. temperature: 85°C

- 3-POL: ... Stk./ KS-TUC / 3
- 5-POL: ... Stk./ KS-TUC / 5



Kabeldose / Cable socket

Typ KD-TUC

- Gehäuse und Kontaktträger: PETP gv.
- Bajonettverriegelung
- Lötanschlüsse
- 3 oder 5-polig
- 10 A / 250 V





- Housing and terminal block: PETP gv.
- Bayonet-locking
- Solder terminals
- 3 or 5-pole
- 10 A / 250 V

max. Betriebstemperatur: 85°C

max. temperature: 85°C

- 3-POL: ... Stk./ KD-TUC / 3
- 5-POL: ... Stk./ KD-TUC / 5



Mehrpolige Steckverbinder / Multipole connectors						
Gehäuseoberteil	Housing					
<ul style="list-style-type: none"> • Gehäuse: Alu-Druckguß • mit Zugentlastung • 6, 10, 16, oder 24-polig • 16 A / 400V 	<ul style="list-style-type: none"> • Housing: Die-cast aluminium • with strain relief • 6, 10, 16, or 24-pole • 16 A / 400V 					
<table border="1"> <tr><td>- 6-POL: ... Stk./ MPSV-GO 06</td></tr> <tr><td>- 10-POL: ... Stk./ MPSV-GO 10</td></tr> <tr><td>- 16-POL: ... Stk./ MPSV-GO 16</td></tr> <tr><td>- 24-POL: ... Stk./ MPSV-GO 24</td></tr> </table>	- 6-POL: ... Stk./ MPSV-GO 06	- 10-POL: ... Stk./ MPSV-GO 10	- 16-POL: ... Stk./ MPSV-GO 16	- 24-POL: ... Stk./ MPSV-GO 24		
- 6-POL: ... Stk./ MPSV-GO 06						
- 10-POL: ... Stk./ MPSV-GO 10						
- 16-POL: ... Stk./ MPSV-GO 16						
- 24-POL: ... Stk./ MPSV-GO 24						
Gehäuseunterteil	Socket					
<ul style="list-style-type: none"> • Gehäuse: Alu-Druckguß • Unterteil offen • mit Verriegelungsbügel • 6, 10, 16, oder 24-polig • 16 A / 400V 	<ul style="list-style-type: none"> • Housing: Die-cast aluminium • open underneath • including locking-clip • 6, 10, 16, or 24-pole • 16 A / 400V 					
<table border="1"> <tr><td>- 6-POL: ... Stk./ MPSV-GU 06</td></tr> <tr><td>- 10-POL: ... Stk./ MPSV-GU 10</td></tr> <tr><td>- 16-POL: ... Stk./ MPSV-GU 16</td></tr> <tr><td>- 24-POL: ... Stk./ MPSV-GU 24</td></tr> </table>	- 6-POL: ... Stk./ MPSV-GU 06	- 10-POL: ... Stk./ MPSV-GU 10	- 16-POL: ... Stk./ MPSV-GU 16	- 24-POL: ... Stk./ MPSV-GU 24		
- 6-POL: ... Stk./ MPSV-GU 06						
- 10-POL: ... Stk./ MPSV-GU 10						
- 16-POL: ... Stk./ MPSV-GU 16						
- 24-POL: ... Stk./ MPSV-GU 24						
Steckereinsatz	Male insert					
<ul style="list-style-type: none"> • Einsatz: Polyamid • Schraubanschluß, 2,5 mm² • 6, 10, 16, oder 24-polig • 16 A / 400V 	<ul style="list-style-type: none"> • Insert: Polyamid • Threaded terminal end, 2,5 mm² • 6, 10, 16, or 24-pole, • 16 A / 400V 					
<table border="1"> <tr><td>- 6-POL: ... Stk./ MPSV-SE 06</td></tr> <tr><td>- 10-POL: ... Stk./ MPSV-SE 10</td></tr> <tr><td>- 16-POL: ... Stk./ MPSV-SE 16</td></tr> <tr><td>- 24-POL: ... Stk./ MPSV-SE 24</td></tr> </table>	- 6-POL: ... Stk./ MPSV-SE 06	- 10-POL: ... Stk./ MPSV-SE 10	- 16-POL: ... Stk./ MPSV-SE 16	- 24-POL: ... Stk./ MPSV-SE 24		
- 6-POL: ... Stk./ MPSV-SE 06						
- 10-POL: ... Stk./ MPSV-SE 10						
- 16-POL: ... Stk./ MPSV-SE 16						
- 24-POL: ... Stk./ MPSV-SE 24						
Buchseinsatz	Female insert					
<ul style="list-style-type: none"> • Einsatz: Polyamid • Schraubanschluß, 2,5 mm² • 6, 10, 16, oder 24-polig • 16 A / 400V 	<ul style="list-style-type: none"> • Insert: Polyamid • Threaded terminal end, 2,5 mm² • 6, 10, 16, or 24-pole, • 16 A / 400V 					
<table border="1"> <tr><td>- 6-POL: ... Stk./ MPSV-BU 06</td></tr> <tr><td>- 10-POL: ... Stk./ MPSV-BU 10</td></tr> <tr><td>- 16-POL: ... Stk./ MPSV-BU 16</td></tr> <tr><td>- 24-POL: ... Stk./ MPSV-BU 24</td></tr> </table>	- 6-POL: ... Stk./ MPSV-BU 06	- 10-POL: ... Stk./ MPSV-BU 10	- 16-POL: ... Stk./ MPSV-BU 16	- 24-POL: ... Stk./ MPSV-BU 24		
- 6-POL: ... Stk./ MPSV-BU 06						
- 10-POL: ... Stk./ MPSV-BU 10						
- 16-POL: ... Stk./ MPSV-BU 16						
- 24-POL: ... Stk./ MPSV-BU 24						

Anschlußkästen
Terminal boxes

Kabelanschluß / Cable connection

Typ AK 235/A

- Gehäuse: Stahlblech, oberflächenbehandelt
 - Anschlußschienen: Messing
 - Schraubanschluß
 - Kabelverschraubung PG 9 oder PG 11 mit Zugentlastung
- Housing: Steel
 - Contact plates: Brass
 - Screw connection
 - PG 9 or PG 11 cable clamp with strain relief

Zum Anschluß mehrerer Heizelemente

For connecting of several heating elements



Klemmstellen: Contact-points:	L:	L1:	Best.Nr.: - Order-N°: -
2	110	80	... Stk./ AK-235A / 110 80
2	130	100	... Stk./ AK-235A / 130 100
2	150	120	... Stk./ AK-235A / 150 120
5	170	140	... Stk./ AK-235A / 170 140
6	190	160	... Stk./ AK-235A / 190 160
7	210	180	... Stk./ AK-235A / 210 180
8	230	200	... Stk./ AK-235A / 230 200
10	270	240	... Stk./ AK-235A / 270 240
11	310	280	... Stk./ AK-235A / 310 280
13	350	320	... Stk./ AK-235A / 350 320

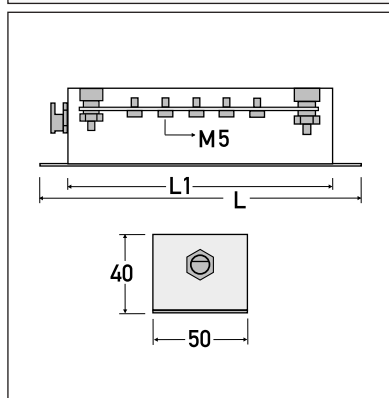

Steckeranschluß / Plug connection

Typ AK 235/B

- Gehäuse: Stahlblech, oberflächenbehandelt
 - Eingebauter Gerätestecker, Typ UFT (siehe Seite 4)
 - Kontaktstifte: Messing
 - 10A / 250V
- Housing: Steel
 - Inbuilt plug, type UFT (see page 4)
 - Contact plates: Brass
 - 10A / 250V



L:	L1:	Best.Nr.: - Order-N°: -
110	80	... Stk./ AK-235B / 110 80
130	100	... Stk./ AK-235B / 130 100
150	120	... Stk./ AK-235B / 150 120
170	140	... Stk./ AK-235B / 170 140

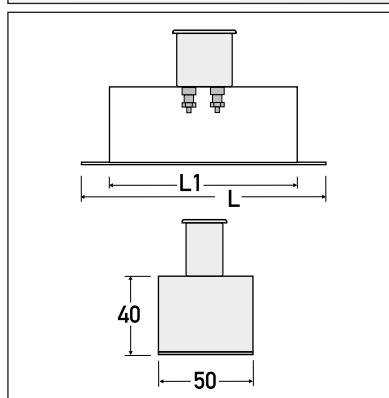

Steckverbinder-Anschluß / Plug-connection

Typ ISO 1024

- Gehäuse: Stahlblech, oberflächenbehandelt
- Eingebauter Gerätestecker, Typ TUC 5-Pol (siehe Seite 7)
- Anschlußschienen: Messing
- Lötanschluß
- 10A / 250V

- Housing: Steel
- Inbuilt plug, type TUC 5-pole (see page 7)
- Contact plates: Brass
- Solder terminals
- 10A / 250V

Zum Anschluß mehrerer Heizelemente

For connecting of several heating elements

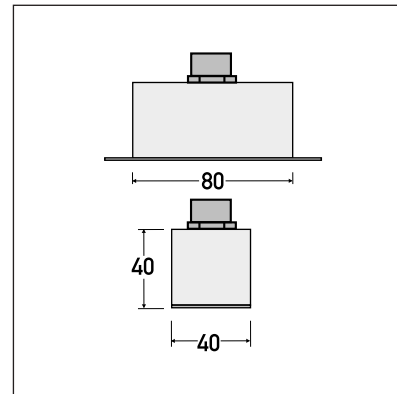

- ... Stk./ ISO 1024

Kabelanschluß / Cable connection

Typ ISO 1021

- Gehäuse: Stahlblech, oberflächenbehandelt
- Deckel verschraubt
- 16 Reihen-Klemmen, 2,5 mm², aufgesteckt auf Normtragschiene
- 6 Kabelzuführungen PG 11
- 16A / 400V

- Housing: Steel
- screwed cover
- 16 Clamps, 2,5 mm², mounted on a "U-Profile" bar
- 6 Cable clamps PG 11
- 16A / 400V

Zum Anschluß mehrerer Heizelemente oder Thermofühler an einem Temperatur-Regelgerät.
Mehrpole-Steckverbinder (nach Bedarf) auf der Rückseite, Kabelzuführung über 6 Kabelverschraubungen PG 11.

For connecting of several cables of heating elements and thermocouples.
With multi-pole connector (on request) on the back and 6 cable clamps (PG 11) on the front.

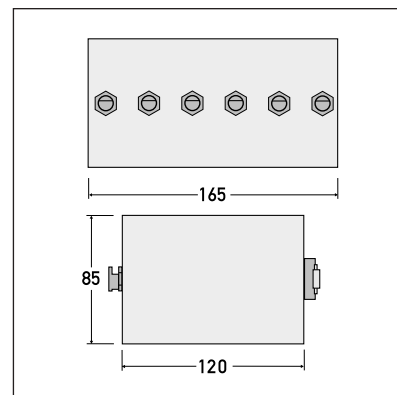

- ... Stk./ ISO 1021

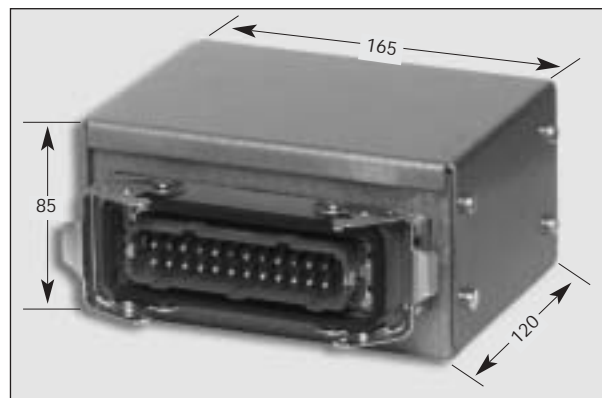

Keramik-Klemmsteine
Ceramik terminal Blocks

Aufreih-Klemmsteine / Terminal blocks

Typ 535

- Gehäuse: Keramik, Metallteile: V2A
 - mit Klemmschrauben M5x20 oder M5x25
 - inkl. Scheiben und Muttern
- Housing: Ceramic, Metal-parts: V2A
 - with screw M5x20 or M5x25
 - incl. nuts and washer

Zum Anschluß mehrerer Heizelemente

For connecting of several heating elements

- M5x20: ... Stk./ K 535-20
- M5x25: ... Stk./ K 535-25



U-Profil

- Metall - U-Profilsschiene zur Befestigung der Klemmsteine Typ 535
 - Länge: 250 mm
- Metal made "U-Profile" bar for the mounting of terminal block Typ 535
 - Length: 250 mm

- ... Stk./ UP 535



Klemmleisten / Terminal blocks

Typ 537/2 (2-polig / 2-pole)

- 2 x 2,5 cm²
- max. 400 V

- ... Stk./ KL 537-2

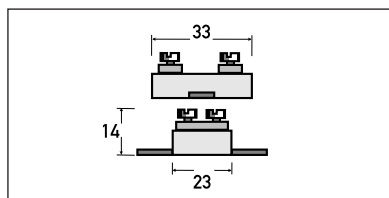

Typ 537/4 (4-polig / 4-pole)

- 4 x 2,5 cm²
- max. 400 V

- ... Stk./ KL 537-4

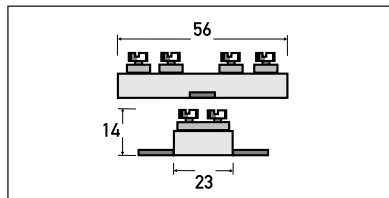

Typ 538/4 (4-polig / 4-pole)

- 4 x 2,5 cm²
- max. 500 V

- ... Stk./ KL 538-4

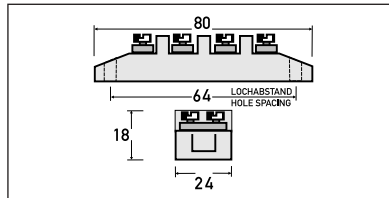

Typ 538/6 (6-polig / 6-pole)

- 6 x 2,5 cm²
- max. 500 V

- ... Stk./ KL 538-6

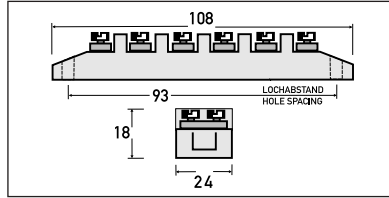

Alle Kontaktschienen, Schrauben und Muttern sind aus V2A Edelstahl gefertigt, die Klemmböcke aus Keramik.
All metal parts made of stainless steel (V2A), terminal blocks made of ceramic.

Amperemeter / Ammeter

Typ IMQ, IMH

- Einbaugerät
- Strommesser Klasse 2,5
- mit Spannbügelbefestigung

Zur Heizkreisüberwachung in der Kunststoffverarbeitung

- Built-in appliance
- Ammeter Class 2,5
- with fixing clip

For the control of the heating circuit of plastic machines



TYP: IMQ



TYP: IMH

Meßbereich: Measuring range:	Querskala / Oblong format	Best.Nr. / Order-N°: - Hochskala / Vertical format
1,0 Amp.	IMQ - 10	IMH - 10
1,5 Amp.	IMQ - 15	IMH - 15
4,0 Amp.	IMQ - 40	IMH - 40
6,0 Amp.	IMQ - 60	IMH - 60
10,0 Amp.	IMQ - 100	IMH - 100
15,0 Amp.	IMQ - 150	IMH - 150
25,0 Amp.	IMQ - 250	IMH - 250
40,0 Amp.	IMQ - 400	IMH - 400

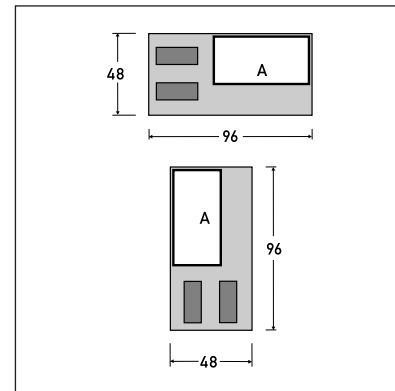

Einzeladern / Wire

Typ GS 260

- Glasseidenisoliert
- Nickellitze, feindrätig
- Glass fibre wrapped
- Nickel conductor



Querschnitt:
Cross-section:

Best.Nr.: -
Order-Nº: -

Durchmesser:
Diameter:

Best.Nr.: -
Order-Nº: -

0,75 mm ²	GS 260 - 07 /mtr.
1,50 mm ²	GS 260 - 15 /mtr.
2,50 mm ²	GS 260 - 25 /mtr.

Schutzleiter
(grün/gelb)
1,50 mm²

Earth conductor (green/yellow)
GS 260 SL - 15 /mtr.

Mehradrige Leitungen / Multi core cable

Typ TP 260

- Panzergeflecht
- Einzeladern glasseidenisoliert
- PTFE-isoliert
- Kupferlitze feindrätig, vernickelt
- * (3x0,75 mm² nur Reinnickel)
- With steel braiding
- Multi core glass fibre insulated cables
- PTFE-insulated
- Cooper conductor, nickelcoated
- * (3x0,75 mm² only nickel)



Querschnitt:
Cross-section:

Best.Nr.: -
Order-Nº: -

3 x 0,75 mm ² *	TP 260 - 307 /mtr.
3 x 1,50 mm ²	TP 260 - 315 /mtr.
3 x 2,50 mm ²	TP 260 - 325 /mtr.
5 x 1,50 mm ²	TP 260 - 515 /mtr.
5 x 2,50 mm ²	TP 260 - 525 /mtr.



Siliconisierte Leitungen / Silicon rubber insulated cables

Typ SAB

- Silicon - Isoliert, hitzebeständig 180°C
- Kupferlitze feindrätig, vernickelt
- Silicon - insulated, max. temperature: 180°C
- Cooper conductor, nickelcoated



Querschnitt:
Cross-section:

Best.Nr.: -
Order-Nº: -

3 x 0,75 mm ²	SAB - 307 /mtr.
3 x 1,50 mm ²	SAB - 315 /mtr.

Thermofühler Leitung / Thermocouple cable

Typ TF

- Querschnitt: 2 x 0,22 mm²
- Panzergeflecht
- Einzeladern glasseidenisoliert
- Fe Cu Ni oder Ni Cr Ni
- Cross-section: 2 x 0,22 mm²
- With steel braiding
- Multi core glass fibre insulated cables
- Fe Cu Ni or Ni Cr Ni



Material:

Best.Nr.: -
Order-Nº: -

Fe Cu Ni	TF - 202 F /mtr.
Ni Cr Ni	TF - 202 N /mtr.

Metallgewebe-Schlauch / Flexible braid hose

Typ MGS

- Metall, geflochten
- flexibel
- Metal insulated sleeve
- flexible



Innendurchmesser:
Inner diameter:

max. 15,0 mm

Best.Nr.: -
Order-Nº: -

MGS /mtr.

Glasseiden-Isolierschläuche / Glass fibre sleeving

Typ Gi

- Temperaturbeständig bis max. 180°C
- flexibel
- Continuous temperature resistance: max. 180°C
- flexible



Innendurchmesser:
Inner diameter:

3,0 mm
4,0 mm
6,0 mm
8,0 mm
10,0 mm

Best.Nr.: -
Order-Nº: -

3,0 mm	Gi - 03 /mtr.
4,0 mm	Gi - 04 /mtr.
6,0 mm	Gi - 06 /mtr.
8,0 mm	Gi - 08 /mtr.
10,0 mm	Gi - 10 /mtr.

Isolierband / Insulation tape

Isolierband auf Glasgewebebasis,
Isolierstoffklasse B, max 130°C

20 mtr. Rolle, 12,0 x 0,18 mm

Glass cloth electrical tape,
Class B insulation, max 130°C

20 mtr. Roll, 12,0 x 0,18 mm



- ... Stk./ IB - 2012

Rohrkabelschuhe / Ring terminal

- Material: Reinnickel
- Bohrung: ø 5,5 mm
- für 1,5 - 4,0 mm² Kabelquerschnitte

max. Kabelquerschnitt:
max. cable cross-section:

1,5 mm
4,0 mm

- Material: Nickel
- Bore-diameter: ø 5,5 mm
- for 1,5 - 4,0 mm² cross-section

Best.Nr.: -
Order-Nº: -

1,5 mm	RKS - 15
4,0 mm	RKS - 40

